

CF-9

Radial Lead Forming Machine

User's Guide

Version 2.1
June 4, 2014

Prepared by
GPD Global® Documentation Department

Copyright© 2014 GPD Global®
All Rights Reserved

GPD Global®
611 Hollingsworth Street
Grand Junction, CO 81505
(970) 245-0408

Warranty

GPD Global (GPD) warrants that this product will be free from defects in material and workmanship for a period of one (1) year from the date of original purchase. GPD will repair, or at its option, replace this GPD product during the warranty period at no charge, provided it is returned (shipping-postage paid) to the GPD, Colorado service facility.

The one year warranty does not cover normal wear and tear to the cutting and forming tooling, since life usually depends on use.

This warranty does not apply if the GPD product has been damaged by accident, abuse, misuse, or misapplication, has been modified without the written permission of GPD, or if any GPD serial number has been removed or defaced.

GPD IS NOT RESPONSIBLE FOR INCIDENTAL OR CONSEQUENTIAL DAMAGES RESULTING FROM THE BREACH OF ANY EXPRESS OR IMPLIED WARRANTY INCLUDING ANY COSTS OR DAMAGE TO PROPERTY, AND, TO THE EXTENT PERMITTED BY LAW, DAMAGES FOR PERSONAL INJURY. THIS WARRANTY IS IN LIEU OF ALL OTHER WARRANTIES. ANY IMPLIED WARRANTIES, INCLUDING IMPLIED WARRANTIES OF MERCHANTABILITY AND FITNESS FOR A PARTICULAR PURPOSE, ARE LIMITED IN DURATION TO ONE (1) YEAR FROM THE DATE OF RECEIPT OF THIS PRODUCT. GPD'S LIABILITY ON ANY CLAIM OF ANY KIND INCLUDING NEGLIGENCE, FOR LOSS OR DAMAGE ARISING OUT OF, CONNECTED WITH OR RESULTING FROM THE BREACH OF ANY EXPRESS OR IMPLIED WARRANTY OR THE DELIVERY, REPAIR, OR USE OF ANY GPD PRODUCT SHALL IN NO CASE EXCEED THE PRICE ALLOCABLE TO THE GPD PRODUCT WHICH GIVES RISE TO THE CLAIM.

Specifications, descriptions, and all information contained in this manual are subject to change and/or correction without notice.

Although reasonable care has been exercised in the preparation of this manual to make it complete and accurate, this manual does not purport to cover all conceivable problems or applications pertaining to this machine.

Safety Instructions

Symbol samples and definitions for the DANGER, WARNING, CAUTION, IMPORTANT and NOTE safety notices used in this document are as follows:

**** D A N G E R ****

Danger notices are used in this document to emphasize life threatening or potentially harmful situations.

W A R N I N G

Warning notices are used in this document to emphasize chance of injury, harm to life or limb due largely to something beyond one's control.

C A U T I O N

Caution notices are used in this document to alert one to avoid danger or harm and where equipment might be damaged if care is not taken.

I M P O R T A N T

Important notices are used in this document to call attention to imperative information.

N O T E

Note is used in this document to call attention to information that is especially significant in understanding and operating the equipment.

Table of Contents

Introduction	1
Function	3
Theory of Operation	4
Machine Part Identification	5
Principal Parts	5
Adjustment Parts	6
Control Panel	7
Die Block Assembly	8
Die Markings	9
Installation	11
Operating Instructions	13
Setup	13
Die Installation	14
Station Adjustment	16
Component Alignment	17
Load Components	18
Power On	18
Process Components	19
Power Off	19
Preventive Maintenance	21
Troubleshooting	23
Slide Travel	24
Slide Clearance	25
Specifications	29
Suggested Spare Parts	31
Appendices	33
Appendix A - Die Information	35
Appendix B - Common CF-9 Lead Forms	37
Appendix C - CF-9 Accessories	39
Appendix D - Electrical Schematic & Assembly Drawing	43
Index	45
Reference <i>CF-9 Component Forming Die Catalog</i>	

Table of Figures

Figure 1	Principal Parts	5
Figure 2	Adjustment Parts	6
Figure 3	Control Panel	7
Figure 4	Die Block Assembly, Station 1	8
Figure 5	Die Forming Style Series	9
Figure 6	Die & Station Markings	9
Figure 7	CF-9 Installation	11
Figure 8	Die Mounting Surface & Die Block Slide	14
Figure 9	Die Alignment & Knife Clearance	14
Figure 10	Ejector Brackets	15
Figure 11	Adjust Large Ejector Bracket	15
Figure 12	Adjust Small Ejector Bracket	15
Figure 13	Station Position Adjustment	16
Figure 14	Die Block Assembly Adjusting Bolts	16
Figure 15	Component Position Relative to Tape Hole	17
Figure 16	Align & Load Components	18
Figure 17	Die Block Assembly Lubrication	21
Figure 18	Die Block Assembly Maintenance	21
Figure 19	Die Block Assembly Slide Travel	24
Figure 20	Die Block Assembly Slide Clearance	25
Figure 21	Die Block Assembly Lubrication	26
Figure 22	GPD's CF-9 Taping Specification Requirements	30
Figure 23	Forming Style Series	35
Figure 24	Examples of Die Numbers	35
Figure 25	Examples of Die Number Location	35
Figure 26	Electronic Component Counter Installation	40

Table of Charts

Chart 1	Preventive Maintenance Schedule	21
Chart 2	Troubleshooting Guide	23

Introduction

This document is intended for use by those who install, operate and maintain GPD's CF-9 Radial Lead Forming Machine (GPD Part# CF9.BASE.120 or CF9.BASE.230).

CF-9 Radial Lead Forming Machine

GPD's self-contained CF-9 Radial Lead Forming Machine has become the industry standard for versatility, accuracy, repeatability, and ease of setup and change over. The CF-9 forms and cuts to length a wide variety of two- and three-leaded taped radial components such as TO-92's, capacitors, transistors, and LED's. It processes both standard and special forms precisely and repeatedly.

Two die stations with standard micrometer scale indicators adjust independently. Performing adjustments with the micrometer scales enables quick setup of proper forming and/or cutting settings.

As the first component moves through the system, it is presented to two die stations. The first die station is generally used to form components, and the second to cut components from the tape. Depending on the components being processed and the desired component lead form, the second station may be used to both cut and form, just cut, or be excluded in order to leave components on tape.

The indexing system, the heart of the CF-9, drives the studded transfer belt. The studs, or pins, on the belt pick up the tape holes and index exactly 1/2" (12.70 mm) every time.

The CF-9 is ruggedly constructed of heavy duty parts and sealed ball bearing shaft assemblies for low maintenance. All of the machine's parts are precisely made and treated to prevent corrosion, enhance appearance, or facilitate proper function.

The tape roller guide includes studded protrusions to hold the component tape solidly in place — the tape cannot run off the drive belt mechanism. Waste tape feeds down a tape exit chute and out to the side of the machine for easy disposal.

The CF-9's capabilities expand with its Loose/Bulk Component Feeder and Automatic Taped Component Re-reeler accessories by combining the functions of several machines into one. Additional accessories such as the Electronic Component Counter, Component Detection System, Lazy Susan, Work Station, and Footswitch are also available to help increase your production and profit.

CF-9 Lead Forming Dies

The CF-9 offers unique versatility through the use of a large selection of dies. The CF-9 operates on a system of dies and die blocks. Each die combination is designed to form a specific lead configuration. Numerous standard and special CF-9 Lead Forming Die sets are available to provide a variety of component forms and lead configurations. Many different die sets for various transistor hole patterns are also available.

A minimal amount of preparation time is required to reset the machine for processing different component sizes. Dies are easily replaced within minutes.

GPD's CF-9 dies are precisely manufactured using a unique die construction process. Most dies are built with a sectional, laminated construction method for exceptional wearing ability. Before lamination, all dies are buffed and polished to exacting smoothness, particularly in the actual forming and cutting areas.

Function

CF-9 Radial Lead Forming Machine

The CF-9 performs the following functions:

- Forms and cuts up to 25,000 radial components per hour with a variable speed motor.
- Produces a variety of lead forms.
- Accommodates components with a wide range of lead diameters.
- Handles a diversity of hole-to-hole spacings.
- Controls accuracy and repeatability through the use of a solid gear train, cam, and cam follower indexing system.

Most cutting and forming needs are covered with the standard dies we offer. Several of the most common component forms the CF-9 produces are illustrated in the *Common CF-9 Lead Forms* appendix.

CF-9 Lead Forming Dies

CF-9 Lead Forming Die sets are available to perform the following functions:

- Produce both common and special configurations. GPD is pleased to design custom dies for you. If you have unusual requirements, your GPD representative will be happy to assist you with any custom die orders.
- Form two-leaded components with up to .400" (10.16 mm) center-to-center dimensions.
- Form three-leaded TO-92 transistors.
- Offer unique versatility through the use of a large selection of different dies to form a wide variety of component shapes.

NOTE

All CF-9 dies will also work on the GPD CF-10 Loose/Bulk Component Lead Former.

Theory of Operation

The CF-9 performs the following steps during a cycle:

1. Feeds taped radial components from the reel holder through a pair of tape roller guides into the feeding mechanism and the forming and cutting die stations.
2. Forms the component in the first die station.
3. Indexes the formed component to the second die station while simultaneously indexing the next component into the first die station.
4. Cuts the formed component from the tape in the second die station, drops the component in the component bin, and disposes of the tape down a waste tape exit chute while simultaneously forming the component at the first die station.
5. Initiates next cycle.

NOTE

Depending on the components being processed and the desired component lead form, die Station 2 may be used to both cut and form, just cut, or be excluded in order to leave components on tape.

Machine Part Identification

The CF-9's principal machine and die elements are identified and illustrated in this section. Information for elements not defined elsewhere is also included here.

Principal Parts

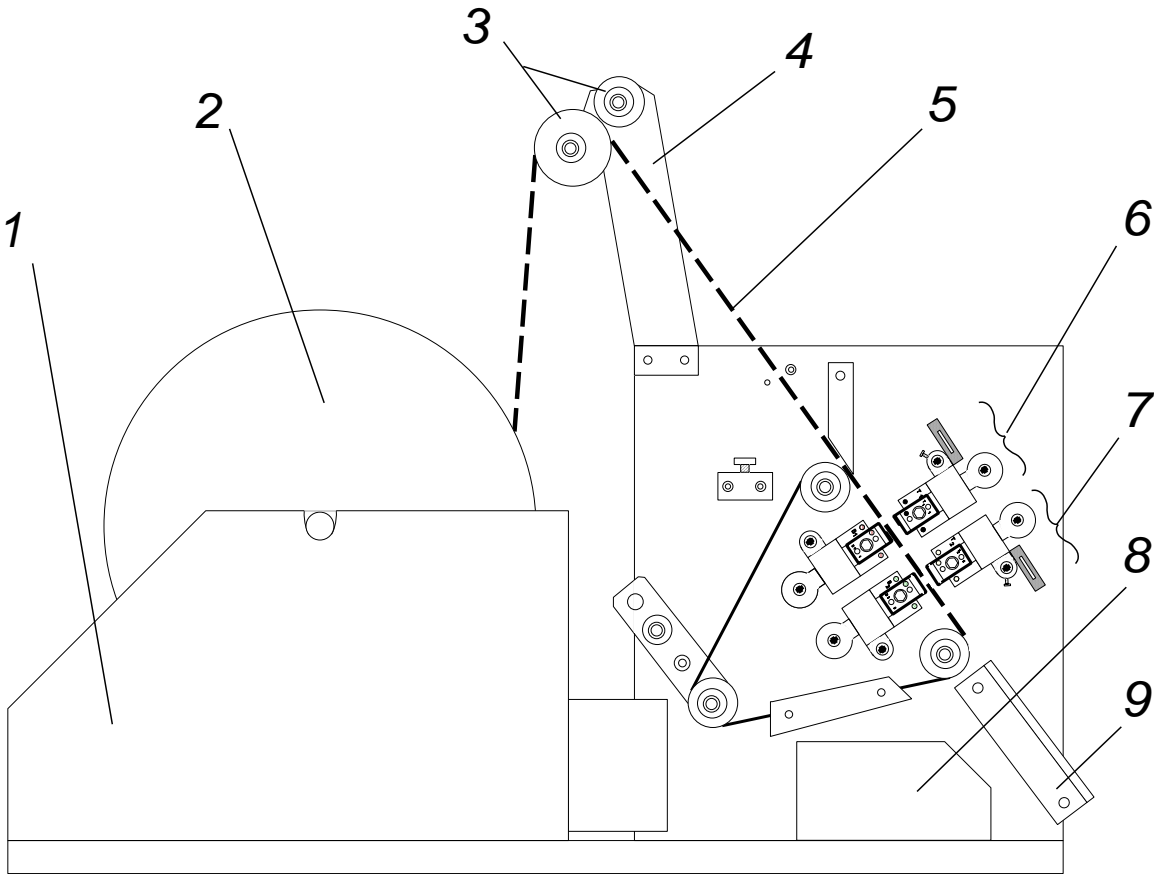

Figure 1 Principal Parts

- | | | | |
|--------|----------------------------|--------|-------------------------------|
| Item 1 | Reel Holder | Item 6 | Die Block Assembly, Station 1 |
| Item 2 | Component Reel / Ammo Pack | Item 7 | Die Block Assembly, Station 2 |
| Item 3 | Tape Roller Guide | Item 8 | Component Bin |
| Item 4 | Tape Guide Arm | Item 9 | Tape Exit Chute |
| Item 5 | Taped Components | | |

Die Stations

Station 1 is adjustable and normally used as a forming station. Station 2, also adjustable, is normally used as a cutting station. More complicated forms may require Station 2 to complete the forming function prior to cutting the component from the tape, or special flattening blocks can be inserted if additional dimple alignment is required.

Adjustment Parts

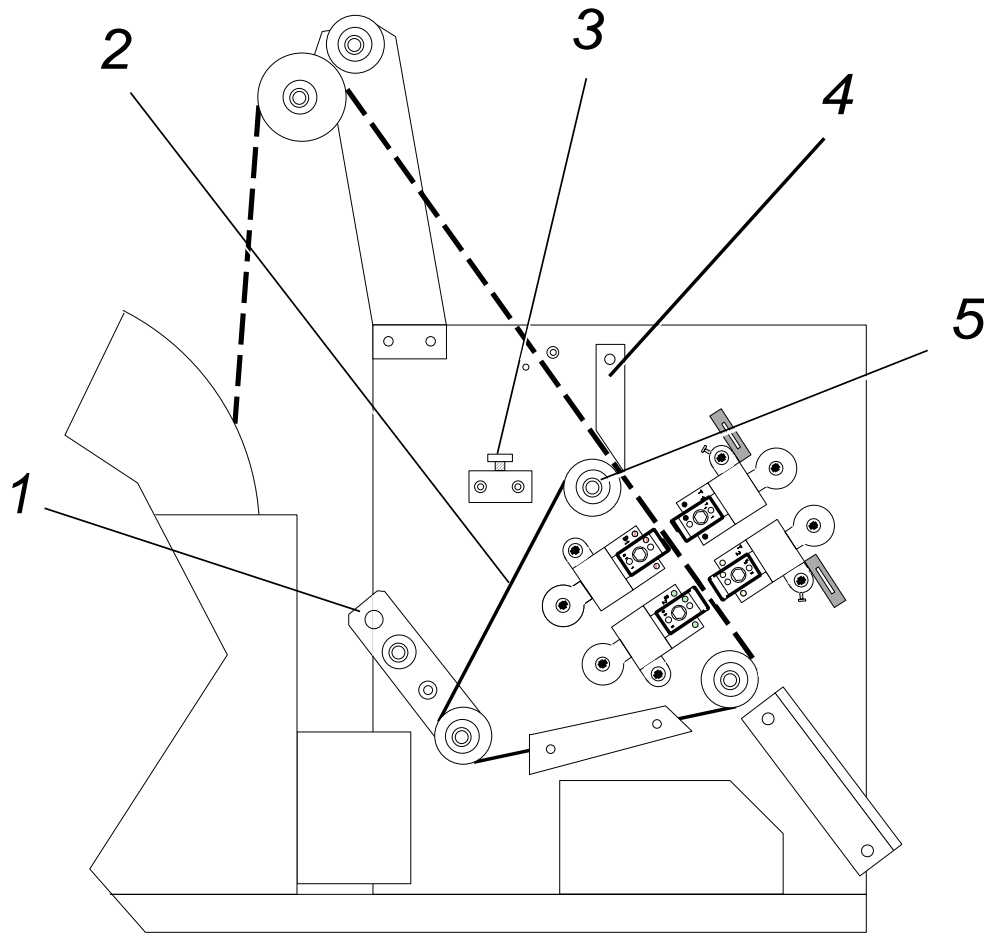

Figure 2 Adjustment Parts

Item 1	Belt Tension Release Bar	Item 4	Component Tape Pressure Plate Lever
Item 2	Transfer Belt	Item 5	Drive Pulley (adjusts Transfer Belt timing)
Item 3	Safety Shield Lock		

Hand Crank

Not shown. The hand crank port is located in the lower left corner of machine's back panel. By inserting the supplied Allen Key in this port, the operator can slowly operate the CF-9 manually, moving all mechanisms during setup, adjustment, testing, or troubleshooting to assure proper die and component positioning. The hand crank can be used to move mechanisms in reverse only during setup and only when no components are loaded.

Safety Shield

Not shown. The safety shield must be in place during machine operations. Machine operations cease whenever the shield is opened.

Control Panel

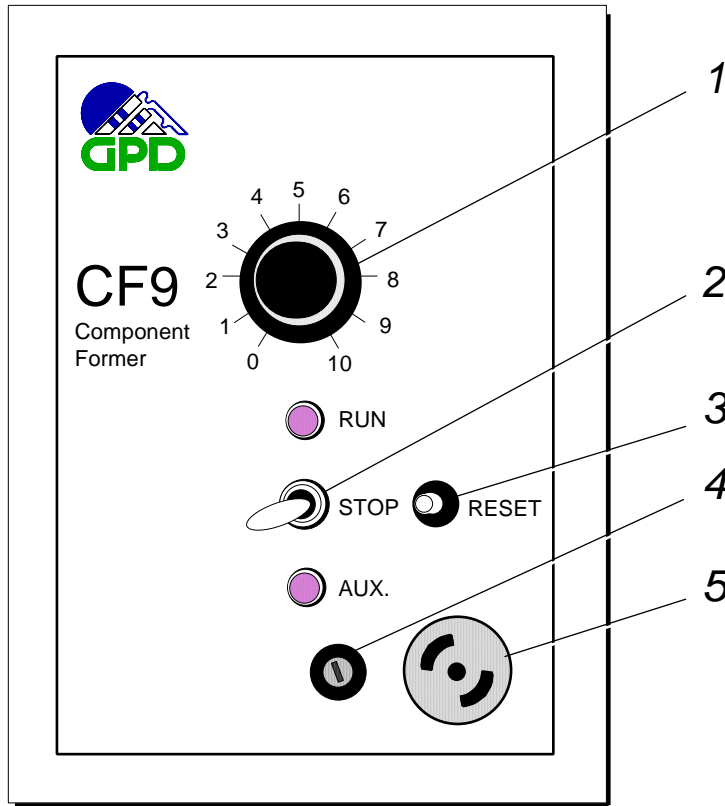

Figure 3 Control Panel

- | | | | |
|--------|-------------------------------|--------|------------------|
| Item 1 | Speed Control | Item 4 | Fuse |
| Item 2 | Power Switch (RUN, STOP, AUX) | Item 5 | Accessory Outlet |
| Item 3 | Reset Button | | |

Speed Control

The speed control regulates both the variable speed motor and power supply and enables the machine to operate in a range from 0 to 25,000 cycles per hour. The operator has full freedom to select whatever speed is appropriate to the work being performed.

Reset Button

As a safety feature, power is not automatically restored by closing the safety shield. To restore power, it is necessary to close the shield and then push the reset button. Normal operation can then be resumed.

Die Block Assembly

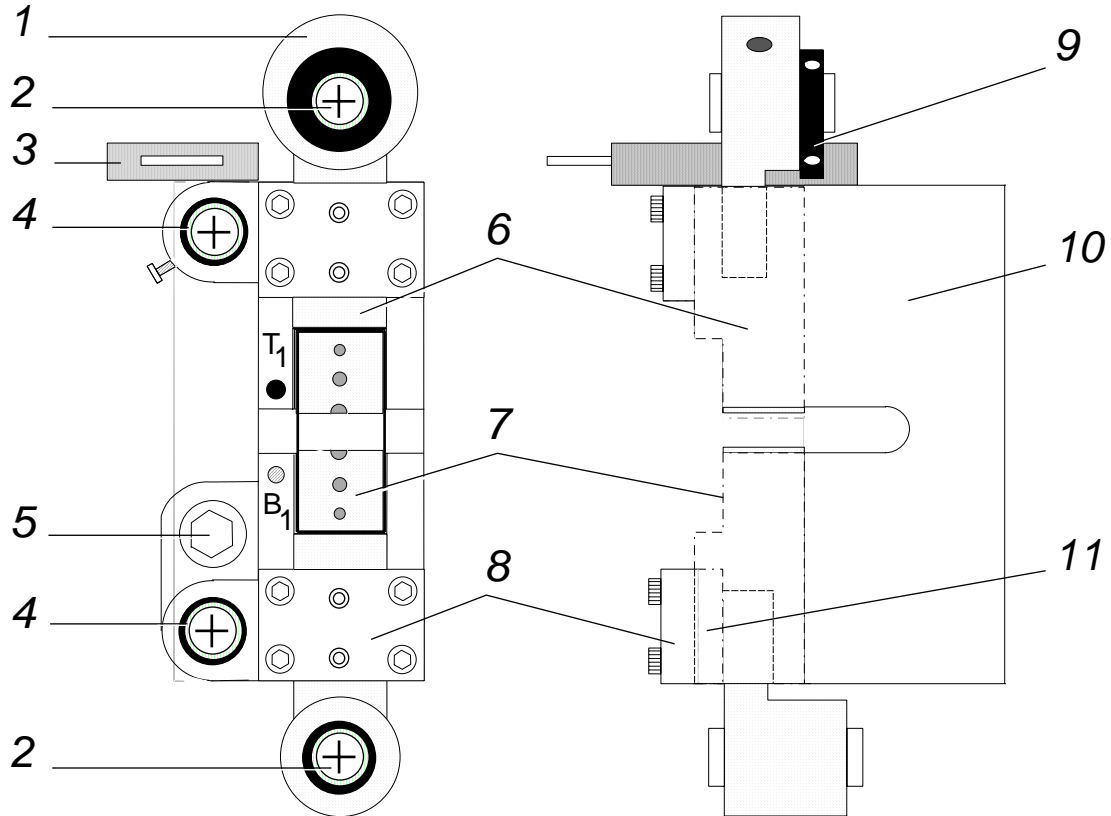

Figure 4 Die Block Assembly, Station 1

Item 1	Eccentric Crank	Item 7	Die Mounting Area
Item 2	Crank Shaft	Item 8	Cover Plate
Item 3	Micrometer Scale Indicator	Item 9	Crank Adjuster
Item 4	Die Station Guide Shaft	Item 10	Die Block
Item 5	Die Block Adjusting Bolt	Item 11	Wear Plate
Item 6	Die Block Slide		

Micrometer Scale Indicator

The micrometer scale indicator mounted on each die station makes the lead cut length adjustment operation quick, easy, and highly accurate to .0005" (0.0127 mm).

Die Markings

Dies and knives are paired and stamp marked with the following symbols so each can be readily identified and installed in the correct station position:

- Forming Style Series Number
- Installation Marking
- Installation Color Dot

Forming Style Series

The forming style series is stamped on its right hand side of each die and knife (Figure 5). Refer to the *Die Information* appendix for specifics.

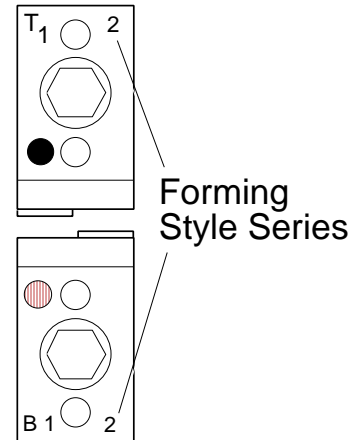

Figure 5 Die Forming Style Series

Installation Marking Installation Color Dot

Characters are stamped on the left hand side of each die half (Figure 6, Item 1) to indicate proper die position in the forming and cutting stations. Corresponding markings are stamped on each station's stationary plate (Item 2). A color dot (Item 3) associated with installation location is also stamped on each die half and stationary plate.

Marking	Color Dot	Location
T1	Black	Top die, Station 1
B1	Red	Bottom die, Station 1
T2	Yellow	Top die, Station 2
B2	Green	Bottom die, Station 2

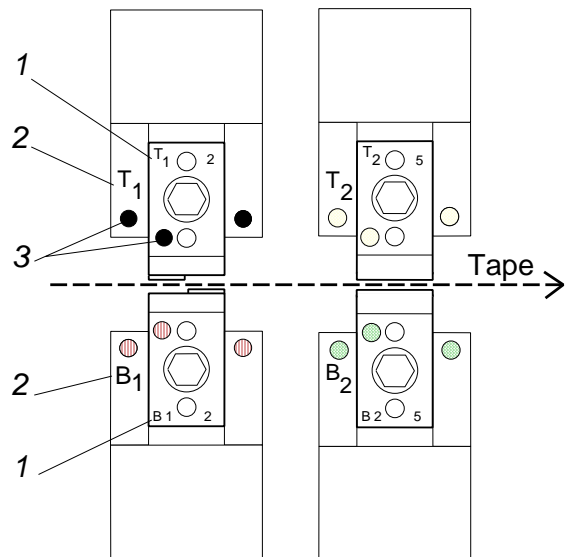

Figure 6 Die & Station Markings

This page left blank (almost).

Installation

1. Carefully unpack and check your CF-9 for possible shipping damage. If any obvious damage is observed, contact GPD's service department prior to operating the machine.
2. Standard equipment included with the CF-9:

1	Standard Die Set	1	Reel / Ammo Pack Holder
1	Standard Knife Set	1	Operating Manual
1	Anti-static Shield and Bin Package	1	Set of Wrenches
1	LCD Micrometer Adjustment Package		
3. Position the CF-9 on a level, stable working surface. If using the optional Lazy Susan or Work Station, install CF-9 on these at this time.
4. Assemble reel holder and tape guide arm. Refer to Figure 7, Items 1 & 2 for proper placement on the machine. The screws (1/4-20x1/2") for securing the reel holder and tape guide arm are located in the appropriate holes in the CF-9's main frame.

CAUTION

Never pull, push or lift machine by reel holder or tape guide arm - this could bend them out of alignment and seriously affect machine performance.

5. Assemble safety shield with hinges and 10-32x3/8" screws attached to shield.
6. Position component bin (Item 3).
7. Install any accessory equipment to be used during processing. Refer to *CF-9 Accessories* appendix.
8. Set speed control to zero (0) position.
9. Hook up electrical power per your local electrical code and machine specifications. Refer to *Specifications*.

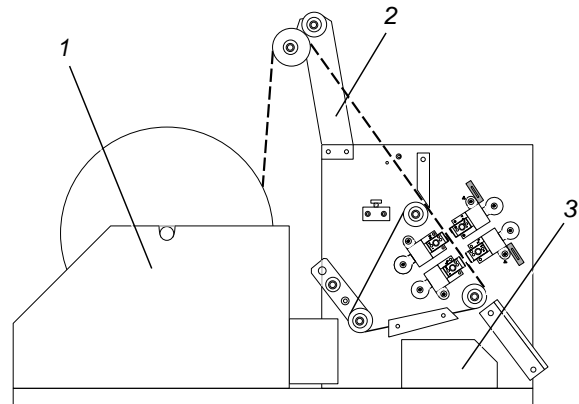

Figure 7 CF-9 Installation

WARNING

Make sure the power supplied is of proper voltage and is fused at the proper amperage. This information is recorded in *Specifications* and on the serial number plate located on the power cord side of the machine.

This page left blank (almost).

Operating Instructions

IMPORTANT

Read this manual before turning the power on. Failure to follow the instructions in this manual could result in damage to the machine and/or dies. Uneven forming of the component leads and/or machine failure could result.

Requirements

- The component reel tape must be sturdy enough to maintain adequate component pitch to prevent improper component feeding. If tape integrity is acceptable, the component body will be supported and stress will not be placed on leads during lead forming.
- Taped component leads must be straight to prevent misfeeding and unacceptable lead forms. GPD's Component Detection System identifies bent components and stops machine operations to prevent die breakage. Refer to the *CF-9 Accessories* appendix.

Suggestions

- Use quality components on quality tape.
- Planning prior to lead forming operations is suggested as this enables users to quickly produce the maximum number of components for a given system configuration.

WARNING

For operator and machine safety, keep fingers, clothing, and foreign objects away from the machine's moving mechanisms while in operation. Failure to do so may result in bodily injury or damage to the machine.

Setup

1. Turn power switch to OFF.
2. Plug machine into appropriate power supply. Refer to *Specifications*.
3. Select appropriate dies and knives. Refer to *CF-9 Component Forming Die Catalog*.
4. Install proper dies and knives according to the following die installation instructions.
5. Use hand crank to check for proper die setup.

Die Installation

To properly position dies in Stations 1 and 2 and insure efficient machine use, follow the die installation steps below. Be sure to test all adjustments with the manual hand crank to verify that component body will not be damaged by forming dies or knives and that the component is centered between the die station tooling.

1. Select dies. Refer to *CF-9 Component Forming Die Catalog*.
2. Clean dies and die slide locating surfaces per *Preventive Maintenance "Daily"* instructions.
3. Install dies:
 - a. Refer to *Die Markings* (page 9) for proper locations.
 - b. Carefully place each die on proper die mounting surface (Figure 8, Item 1) and bolt in place with a 5/8" (15.75 mm) screw. Then manually turn machine's hand crank (page 6) until die block slides (Item 2) are in their fully closed position.

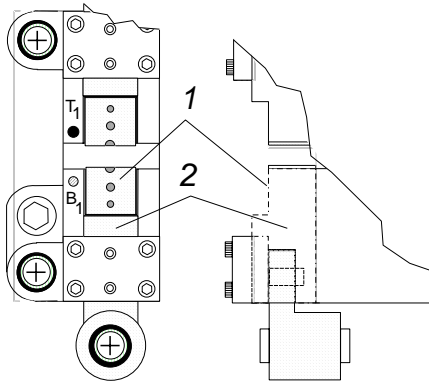

Figure 8 Die Mounting Surface & Die Block Slide

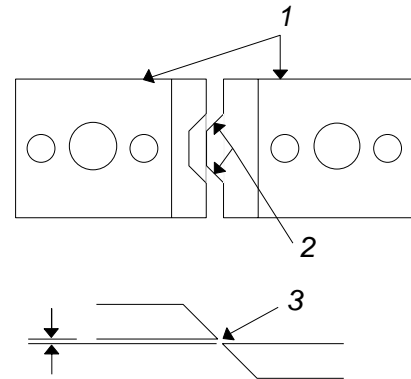

Figure 9 Die Alignment & Knife Clearance

- c. Visually inspect alignment of die forming area to insure equal spacing on both sides (Figure 9, Item 2).
 - d. Properly align die edges (Item 1) in relation to each other, centering each die and knife in its station.
 - e. Adjust air gap clearance between dies (Item 3) to an even distance.
4. Check die alignment with hand crank prior to powering on machine.

IMPORTANT

The hand crank can be used to move mechanisms in reverse only during setup and only when no components are loaded in machine.

5. Adjust die stations as necessary to obtain desired form and cut by aligning components with dies and adjusting each station's height per the following *Station Adjustment* and *Component Alignment* instructions.

6. Install and adjust ejector brackets if required. Required usage is indicated for each die, when appropriate, in the *CF-9 Component Forming Die Catalog*. Certain complicated lead forms require ejector bracket installation to insure that component does not remain in die. If ejector bracket installation and adjustment is not required, skip to *Station Adjustment* on page 16.

Suggestion: Remove the small ejector brackets when not required to simplify die installation.

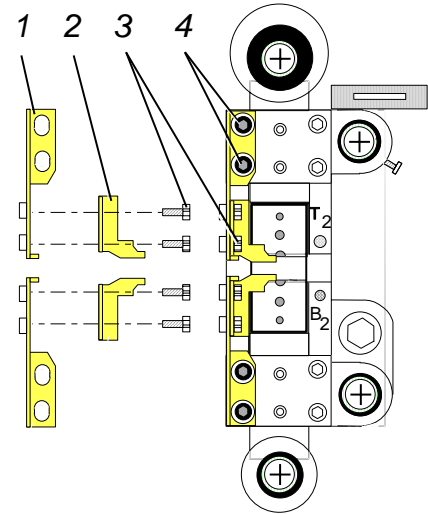

Figure 10 Ejector Brackets

Two sets of ejector brackets are factory mounted on die Station 2 (Figure 10).

Each large ejector bracket (Item 1) mounts to the Station 2 die block assembly with two screws (Item 4). Each small ejector bracket (Item 2) mounts to the large ejector bracket with two screws (Item 3).

Adjust for Component Body Thickness:

- a. Loosen screws (Figure 10, Item 4).
- b. Adjust each large ejector bracket (Item 1) to obtain an air gap of approximately 1/32" (0.794 mm) as illustrated in Figure 11.
- c. Tighten screws.

Adjust for Component Body Height:

- a. Loosen screws (Figure 10, Item 3).
- b. Align center line of component body between small ejector brackets as illustrated in Figure 12.
- c. Tighten screws.

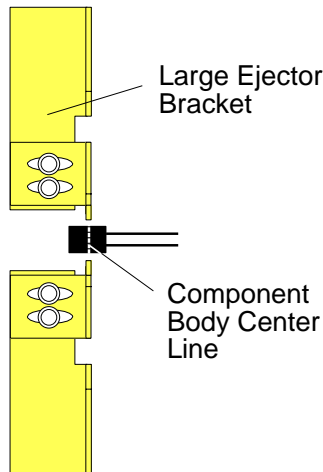

Figure 11 Adjust Large Ejector Bracket

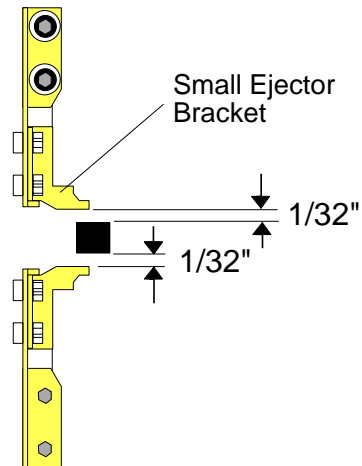

Figure 12 Adjust Small Ejector Bracket

Station Adjustment

The CF-9's die stations are independently adjustable to control forming and cutting locations. The action performed on component leads by each die station can be relocated from a zero (0) position. GPD suggests setting the zero (0) reference point at the machine's upright plate (Figure 13, Item 1). This position also corresponds with the lead wire point of attachment to the tape. Refer to *Taping Specifications* on page 30.

Backlash is eliminated during station adjustment by three (3) beveled washers located on each station adjusting bolt.

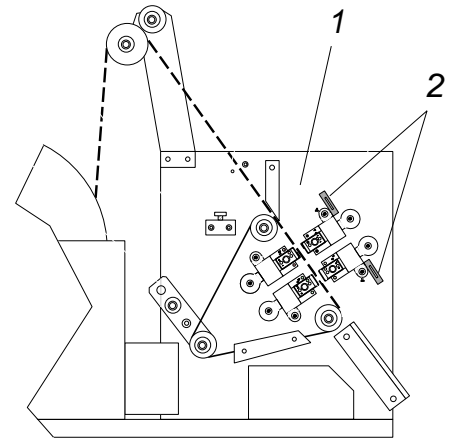

Figure 13 Station Position Adjustment

The standard micrometer scale (Item 2) attached to each station, indicates the distance from the component's point of attachment on the tape to the point of station action on the component lead. These scales are accurate to .0005" (0.0127 mm).

<u>Cut Lead Length</u>	<u>Station Position</u>	<u>Station Action Location</u>
Longest	Fully retracted	Zero (0) position - the point at which component attaches to tape.
Shortest	Fully extended	The point as near as possible to the component body. Each extension movement of station position creates a correspondingly shorter lead length.

To adjust station position:

1. Position die block against machine upright plate.
2. Turn on micrometer scale and reset to zero (0).
3. Adjust die station using supplied 1/4" T-handle wrench in station die block adjusting bolt (Figure 14).
 - a. To extend station, turn wrench counter-clockwise.
 - b. To retract station, turn wrench clockwise.

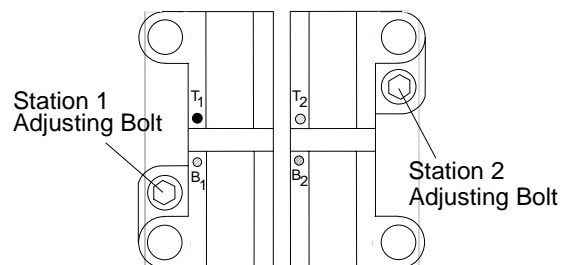

Figure 14 Die Block Assembly Adjusting Bolts

4. Record your micrometer setting. Then machine can be setup quickly the next time you process the same component type.
5. Repeat *Station Adjustment* procedure for remaining die station.

Component Alignment

The CF-9 indexes exactly 1/2" (12.70 mm) every time, however, component position relative to the tape hole may vary from your last run due to variances between vendors or lots because:

- Distance from tape hole to component lead wire may vary (Figure 15, Item 1).
- Tape hole may be located between or under component (Items 2 & 3).

A variance requires readjusting component alignment with die stations — a simple matter of repositioning a pulley (Figure 16, Item 4).

CAUTION

Testing component position relative to dies **MUST** be done prior to automatic machine operations.

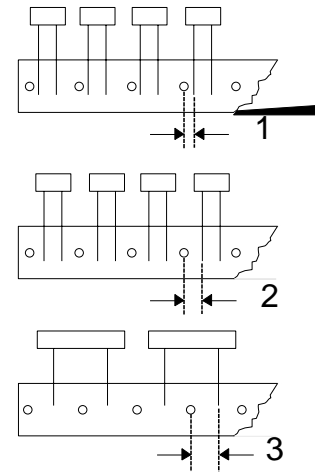

Figure 15 Component Position Relative to Tape Hole

To align components with die stations:

1. Manually index machine with hand crank just until components are centered between dies and just before die touches component wires. Turn hand crank slowly while visually inspecting for the relative position between components and tape holes.

CAUTION

Dies should just start coming together - they should NOT be closed or touching component.

CAUTION

DO NOT rotate mechanisms in reverse to check timing.

2. Loosen bolt in drive pulley (Figure 16, Item 4) with supplied 3/16" wrench.
3. Manually turn pulley in either direction to centrally position a component between each die station.
4. Lock pulley in its new position by re-tightening the bolt.
5. Repeat step 1 to recheck tape alignment.

Load Components

1. Press down on component tape pressure plate lever (Figure 16, Item 3) to lift plate and open component tape pathway.
2. Place tape's first hole over a pin on the transfer belt (Item 1).
3. Release component tape pressure plate lever.
4. Using hand crank, manually index first component to center of die Station 1.
5. Test all adjustments with the manual hand crank to verify that component body will not be damaged by forming dies or knives and that the component is centered between the die station tooling.

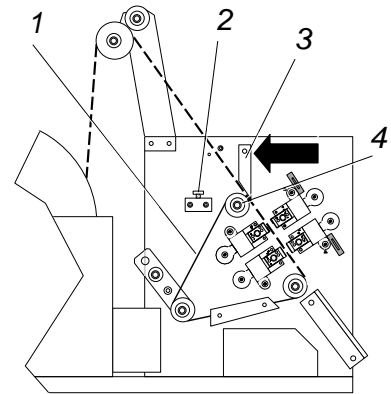

Figure 16 Align & Load Components

CAUTION

If machine is not properly adjusted, damage to components and dies may result.

6. If further adjustments are necessary, repeat *Setup* procedure on page 13.

Power On

1. Close and lock safety shield in place with safety shield lock (Figure 16, Item 2).

WARNING

For operator's safety, do not operate machine without safety shield in place and do not defeat the safety switch.

2. Set speed control to zero (0). If using optional accessories, such as the footswitch or electronic component counter, set power switch to AUX position. The auxiliary mode indicator will light if the CF-9 is plugged in.
3. Press reset button.

NOTE

As a safety feature, power is not automatically restored when safety shield is closed. Normal operations resume when reset button is pushed.

4. Turn power switch to ON.

Process Components

1. Position component reel or ammo pack of taped components in reel holder.
2. Load components. Refer to *Load Components* on page 18.
3. Close safety shield and press reset button.
4. Run machine very slowly to verify proper adjustment. Make further adjustments if necessary to achieve desired results.

CAUTION

Testing component position relative to dies **MUST** be done prior to automatic machine operations.

5. Increase machine speed rate to desired setting and process components.
6. To process a different component form or type, repeat *Setup* procedure on page 13.

Power Off

1. Set speed control to zero (0).
2. Turn power switch to OFF.
3. Remove all dies and clean with a rust inhibitor and lubricate mechanical moving parts per *Preventive Maintenance*.

This page left blank (almost).

Preventive Maintenance

The preventive maintenance steps in this section are intended primarily for the machine operator, however, only qualified service or maintenance personnel should perform the steps requiring access to the machine's cabinet interior. The CF-9 is constructed so that pulleys, belts, and bearings should not need to be replaced for many years, provided the machine is used according to instructions.

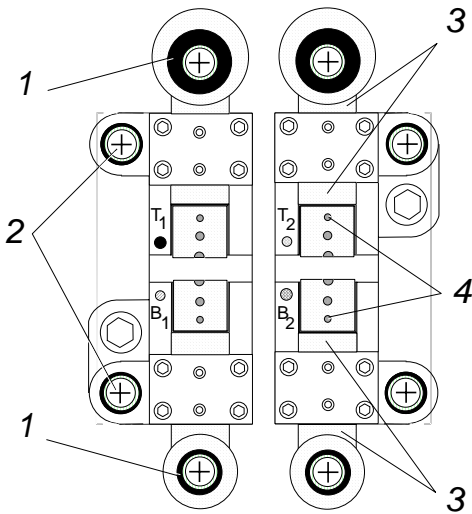

Figure 17 Die Block Assembly Lubrication

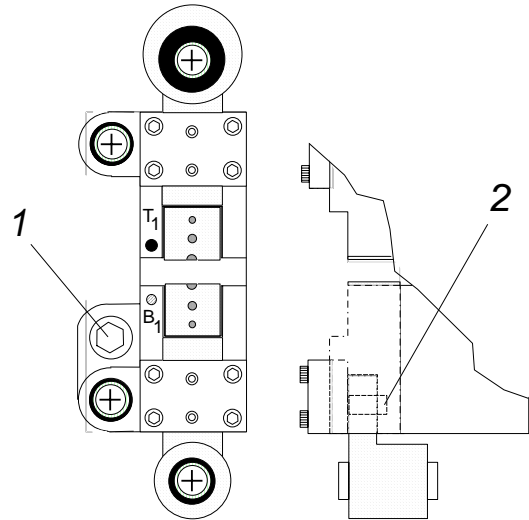

Figure 18 Die Block Assembly Maintenance

Preventive Maintenance Schedule

Interval	Location	Action
Daily (8 hours of operation)	Dies/Knives	Remove all dies/knives, inspect for wear, and clean with rust inhibitor.
		Inspect for foreign matter or dust build-up. Brush clean.
	Die Block Assembly	Inspect and lubricate eccentric shafts and bushings (Figure 17, Item 1) and die block guide shafts (Item 2) with a light machine oil (3-in-1).
		Place a drop of light machine oil (3-in-1) on slide surfaces (Figure 17, Item 3) and in lubrication hole (Item 4).
		Apply oil to each of the four crank pins (Figure 18, Item 2).
	Drive Belt	Inspect belt pins and cogs for wear.

Schedule continues on following page.

Preventive Maintenance Schedule

(continued)

Interval	Location	Action
Monthly	Die Block Assembly	Clean die block adjusting bolt (Figure 18, Item 1) with solvent and apply a small amount of oil to its thread near machine upright plate.
	Inside Cabinet	Inspect component drive belt for proper tension.
		Spray molly grease on gears. Wipe off excess oil.
		Lightly grease cam lobes and cam follower rollers. Wipe off excess grease.
	Check motor brushes and motor drive belt. Replace if they appear worn or frayed.	
	CAUTION: DO NOT attempt to remove or replace a drive belt without first loosening the motor mount screws.	
Yearly	Safety Shield	Apply a drop of light machine oil on each safety shield hinge. Wipe off excess oil.

Troubleshooting

The CF-9's hand crank is a useful troubleshooting feature enabling you to manually move all mechanisms. Simply insert the supplied Allen key in the hand crank port and turn. The hand crank can be used to move mechanisms in reverse only during setup and only when no components are loaded in machine.

Adjustment instructions for slide travel and slide clearance follow the guide below.

Troubleshooting Guide

Problem	Possible Cause	Action
Dies, knives, and/or bushings damaged or wearing prematurely.	Incorrect setup.	Verify that proper tooling is being used. Refer to die catalog for correct die/knife and application combination.
		Verify dies/knives are properly matched.
		Verify that tooling is properly adjusted per <i>Setup</i> .
	Die/knife striking component.	Inspect and set per <i>Die Installation</i> .
	Ejector brackets not installed.	Install ejector brackets per <i>Die Installation</i> instructions.
	Foreign matter, dust build up.	Inspect and clean per <i>Preventive Maintenance</i> .
	Incorrect slide gap.	Check gap with gauge block per <i>Slide Travel</i> .
	Incorrect die alignment.	Inspect and set per <i>Die Installation</i> .
	Incorrect slide clearance.	Inspect and set per <i>Slide Clearance</i> .
Machine performance generally poor.	Incorrect size screw securing die.	Secure die with correct size screw.
	Foreign matter, dust build up.	Inspect and clean per <i>Preventive Maintenance</i> .
	Inadequate lubrication.	Oil per <i>Preventive Maintenance</i> .
	Worn parts or dies.	Inspect and replace as necessary.
	Incorrect die alignment.	Inspect and set per <i>Die Installation</i> .
	Transfer belt timing.	Set timing with drive pulley (page 6, Item 5).
Component tape slipping off belt.	Incorrect size screw securing die.	Secure die with correct size screw.
	Belt studs missing or loose.	Replace belt.
	Transfer belt tension slack.	Reset belt tension.
	Misaligned reel holder.	Realign or replace reel holder.
	Missing pins on tape guide arm.	Replace pins or tape guide arm.
Incorrect size screw securing die.	Secure die with correct size screw.	

Guide continues on following page.

Troubleshooting Guide

(continued)

Problem	Possible Cause	Action
Machine cutting improperly.	Slide clearance too large.	Reset slide travel per <i>Slide Clearance</i> .
	Incorrect slide gap.	Set gap per <i>Slide Travel</i> .
	Worn eccentric shaft bushing.	Replace bushing.
	Worn dies.	Replace or repair dies.
	Incorrect size screw securing die.	Secure die with correct size screw.
No machine movement.	Broken drive belt.	Replace drive belt.
	Blown fuse.	Replace fuse. NOTE: As a preventive measure, turn speed control to zero (0) before turning machine on.
	Power not restored after closing safety shield.	Press reset button.
	Machine not plugged in.	Plug machine in per <i>Specifications</i> .
	Machine not turned on.	Turn machine on per <i>Operating Instructions</i> .
	Speed control set to zero (0).	Set speed control to appropriate operating speed.
	Drive pulley set screws loose.	Tighten set screws.
	Incorrect size screw securing die.	Secure die with correct size screw.

Slide Travel

To adjust slide travel:

1. Unplug machine.
2. Insert provided 1.934" gauge block (Figure 19, Item 1) while manually turning machine's hand crank until die block slides (Item 5) are fully closed.
3. Check for gauge block movement. If movement does not occur, proceed to *Slide Clearance*. If movement does occur, adjust the crank adjuster (Item 3):
 - a. Loosen crank set screws (Item 2).
 - b. Use wrench in crank adjuster holes (Item 4) to rotate crank adjuster until gauge block no longer moves.
 - c. Tighten eccentric crank screws.
 - d. Replace bushings if movement cannot be eliminated through adjustment.

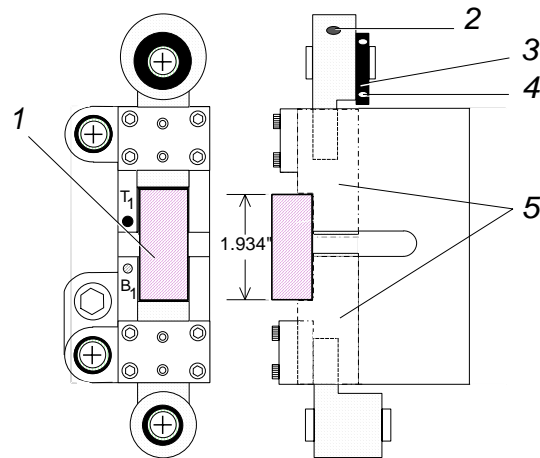

Figure 19 Die Block Assembly Slide Travel

Slide Clearance

To adjust slide clearance:

1. Remove die block assembly. Station 1 die block assembly is illustrated in Figure 20.
 - a. Remove from the CF-9:
 - Tape exit chute
 - Component transfer belt
 - Transfer belt guide and component tape pressure plate (located on either side of transfer belt)
 - b. Raise die block approximately 1" (25.40 mm) from machine upright plate using machine's die block adjusting plate using machine's die block adjusting bolt (Figure 20, Item 3).
 - c. Remove mounting screws from micrometer scale's lower mounting block.
 - d. Turn die block adjusting bolt until die block no longer moves and then slide die block straight off machine.

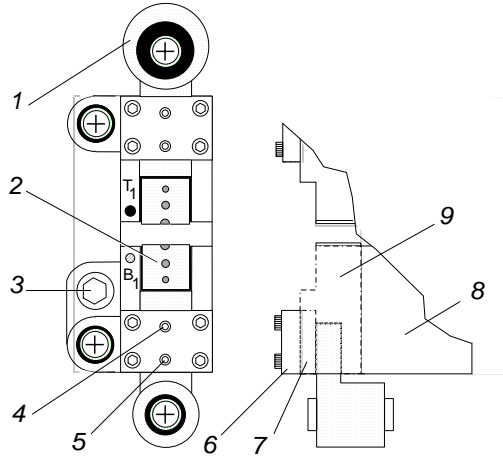

Figure 20 Die Block Assembly Slide Clearance

2. Clean parts.
 - a. Remove and discard set screws in cover plate (Figure 20, Item 6).
 - b. Remove slide (Item 9) from die block.
 - c. Use a degreaser (brake cleaner) to remove all oil from slide, die block, and wear plate (Items 9, 8, and 7).

CAUTION

Do not expose micrometer scales to degreaser (brake cleaner) as it clouds the clear face plate.

- d. Measure all surfaces for wear and inspect for scratches and gouges. Replace parts if raised material is visible on working plane.
 - e. Lightly stone all surfaces.
 - f. Blow dry all parts.
3. Reassemble die block.
 - a. Install slides in die block.

NOTE

Position slide with the eccentric bushing in the eccentric crank (Item 1) in die block's top half (T1 or T2).

- b. Slip wear plate face up between cover plate and slide.
- c. Align wear plate counter sunk holes with cover plate set screws.
- d. Install new set screws and lightly tighten.
- e. With slides in closed position, locate a dial indicator on die mounting surfaces (Item

8) and compare heights. For mated dies to function together properly, replace dies and/or slide blocks if heights are not within .0005" (0.0127 mm) of each other.

4. Set clearance.
 - a. Loosen cover plate's inner set screw (Figure 20, Item 4) approximately a quarter turn.
 - b. Slowly loosen outer set screw (Item 5) just until slide moves freely.
 - c. Tighten inner set screw until a slight drag is felt.
 - d. Install die screw in slide to prevent slide from slipping out of die block.
 - e. Position slide flush with back side of die block.
 - f. Locate a dial indicator on the slide's die mounting surface and set the clearance to .0007 - .001" (.0178 - .0254 mm) by pulling up on die screw. After clearance is set, verify that slide moves freely.

NOTE

If slide does not move freely, loosen outer set screw slightly. Recheck clearance.

- g. Secure screws by applying modest amount of penetrating thread locker (Loctite #290).
 - h. Repeat step 4. for remaining slides.

5. Lubricate parts.
 - a. Generously apply 5 weight oil (3-in-1) to all sides of slide and crank pin (Figure 21, Item 3), working in thoroughly.

CAUTION

DO NOT USE A PENETRATING OIL (WD-40) AS THIS WILL CAUSE DIE BLOCK SEIZURE.

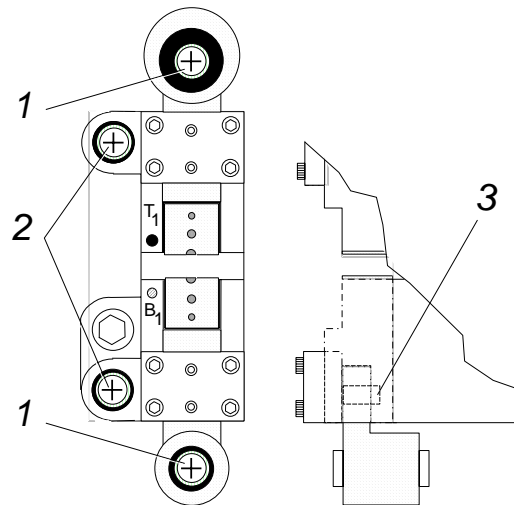

Figure 21 Die Block Assembly Lubrication

6. Reinstall die block assembly.
 - a. Slide die block assembly straight onto machine until die block adjusting bolt reaches hole.
 - b. Thread die block adjusting bolt into hole.
 - c. Replace mounting screws for digital scale's lower mounting block.

- d. Position die block assembly approximately 1" (25.40 mm) from machine upright plate using die block adjusting bolt.
- e. Lay machine on its back cover with die blocks up and cabinet's back air vent clear. Run machine in this position for approximately one (1) hour to allow oil to distribute evenly. During this time period, slowly increase machine speed and check cover plate and die block for heat.

CAUTION

IF EXCESSIVE HEAT IS DETECTED OR A SQUEAK IS HEARD, STOP THE MACHINE. REPEAT COMPLETE *SLIDE CLEARANCE* PROCEDURE.

- f. Reassemble the following:
 - Digital scale lower mounting block screws
 - Belt guide and pressure plate
 - Component transfer belt (Adjust so belt is taut.)
 - Tape exit chute
 - Die screws
- g. Reset slide travel adjustment - refer to *Slide Travel* on page 24.

This page left blank (almost).

Specifications

Power Requirements

120 Volt Model

120 Volts
 Neutral
 Safety (Earth) Ground
 5 Amps
 60 Hz

230 Volt Model

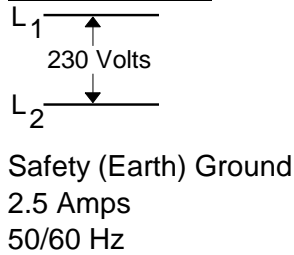

Dimensions

	<u>Standard CF-9</u>	<u>CF-9 with Reel Holder</u>	<u>CF-9 Work Station</u>
Height	12.00 inches (304.80 mm)	18.62 inches (472.95 mm)	29.50 inches (749.30 mm)
Length	13.25 inches (336.55 mm)	13.25 inches (336.55 mm)	26.00 inches (660.40 mm)
Width	13.50 inches (342.90 mm)	28.00 inches (711.20 mm)	39.00 inches (990.60 mm)

Weight

Standard CF-9 58 lbs. (26.31 kg)

Capacities

Production Rate

The CF-9 is capable of forming and cutting up to 25,000 components per hour.

Micrometer Scale

Display increments to .0005" (0.0127 mm)
 ±.002" Repeatability

Taping Specifications

The CF-9 will process components if taped to the E.I.A. standards listed below for taping of radial components AND there is a minimum of .300" (7.62 mm) operating clearance. In some cases, standard tooling may work with less than this minimum operating clearance.

Custom tooling or custom taping may be required in certain instances.

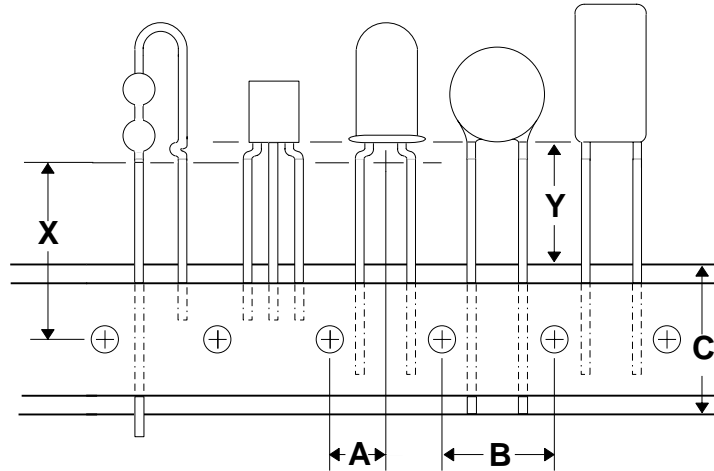

Figure 22 GPD's CF-9 Taping Specifications

GPD CF-9 Taping Specification Limits

Symbol	Definition	Inch	MM
X	Height to seating plane (formed leads)	.300 ± .010	7.62 ± 0.25
Y	Operating Clearance - Seating plane (straight leads)	All dies except style 8A	.300 minimum
		8A style die	.350 minimum

E.I.A. Taping Specification Limits

Symbol	Definition	Inch	MM
A	Component centering	.250 ± .012	6.35 ± 0.30
B	Sprocket hole pitch	.500 ± .012	12.70 ± 0.30
C	Carrier tape width	.710 + .039 to - .020	18.00 + 1.00 to - 0.50

Suggested Spare Part Kits

The following suggested spare parts kits for the GPD CF-9 list the items included in each kit and the GPD part number for each item.

GPD Part Number	Part Description	Qty.
925-1-2	120V 60Hz Spare Parts Kit (consists of the following items)	1
	BELTS	
901-3-101	Transfer Belt	1
D0001	Motor Belt	1
	INDEX WHEEL ASSEMBLY	
806-1-3	Roller	16
G1007	Retaining Ring	16
	FUSE	
4300-0026	Fuse MDL 5A, Slow Blow	1
925-1-3	230V 50/60Hz Spare Parts Kit (consists of the following items)	1
	BELTS	
901-3-101	Transfer Belt	1
D0001	Motor Belt	1
	INDEX WHEEL ASSEMBLY	
806-1-3	Roller	16
G1007	Retaining Ring	16
	FUSE	
4300-0025	Fuse MDL 2.5A, Slow Blow	1

Suggested Spare Parts

The following suggested spare parts listing is for those customers in locations where next day delivery service from the USA is not available.

GPD Part Number	Part Description	Qty.
120V 60 Hz Spare Parts		
G1003	Circlip	10
L0503	Bushing	2
L0601	Bushing	2
2200-0008	Speed Control, 120V, 60 Hz	1
821-4-12	Circlip Plier	1
901-1-102	Die Station #2	1
925-1-2	Spare Parts Kit, 120V	1
230V 50/60 Hz Spare Parts		
G1003	Circlip	10
L0503	Bushing	2
L0601	Bushing	2
2200-0014	Speed Control, 230V, 50/60 Hz	1
821-4-12	Circlip Plier	1
901-1-102	Die Station #2	1
925-1-3	Spare Parts Kit, 230V	1

Appendices

Table of Contents

Appendix A - Die Information	35
Forming Style Series	35
Die Number	35
Appendix B - Common CF-9 Lead Forms	37
Appendix C - CF-9 Accessories	39
Lead Forming Dies	39
Component Detection System	39
Electronic Component Counter	39
Footswitch	40
Lazy Susan (Rotating Machine Platform)	40
Loose/Bulk Component Feeder	41
Taped Component Re-Reeler	41
Work Station	41
Appendix D - Electrical Schematic & Assembly Drawing	43

This page left blank (almost).

Appendix A - Die Information

Forming Style Series

The forming style series is stamped on the right hand side of each die and knife (Figure 23):

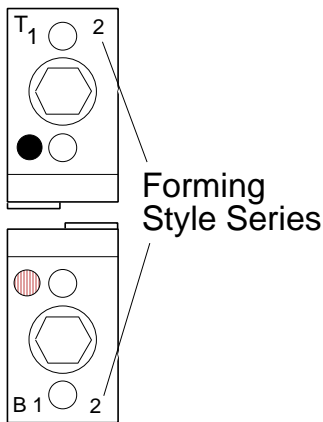

Figure 23 Forming Style Series

Forming Style Series

<u>Number</u>	<u>Description</u>
1	Die, 3 Lead Radial (typically TO-92), In-Line
2	Die, 2 Lead Radial, Stand-Off, Opposing Dimple
2C	Die, 2 Lead Radial, Lock-In Stand-Off, Opposing Dimple
3	Die, 2 Lead Radial, Lock-In Stand-Off
4A	Die, 2 Lead Radial, Spreading
4B	Die, 2 Lead Radial, Reducing
5	Knife
7 *	Die, 2 Lead Radial, 90° Bend
8A	Die, 2 Lead Radial, Spreading, Lock-In Stand-Off
8B	Die, 2 Lead Radial, Reducing, Lock-In Stand-Off
10	Die, 2 Lead Radial, Stand-Off Lock-In
11	Die, 2 Lead Radial, Flush Mount Lock-In

* NOTE: GPD has an adjustable 90° bend 7-style die available. Call GPD for details. (970) 245-0408

Die Number

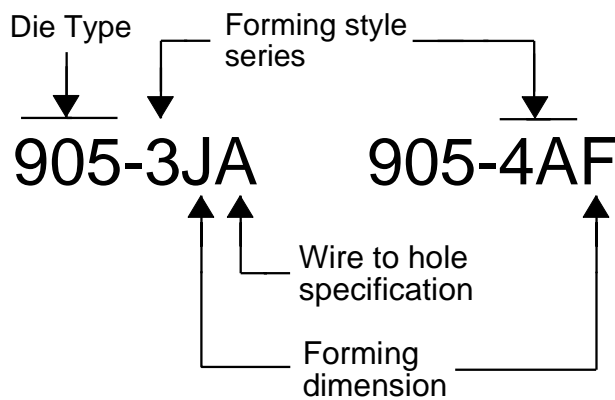

Figure 24 Examples of Die Numbers

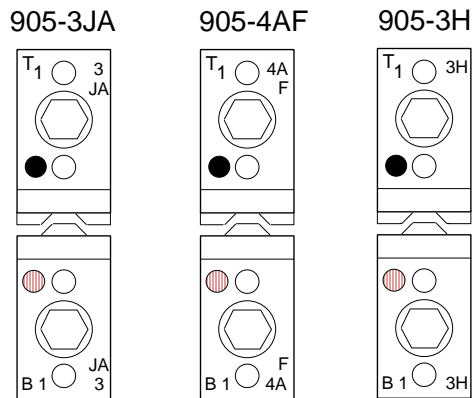















Figure 25 Examples of Die Number Location

For further die specification details, refer to the *CF-9 Component Forming Die Catalog*.

This page left blank (almost).

Appendix B - Common CF-9 Lead Forms

Some examples of the most common component forms produced by the CF-9 are shown below.

<u>Form</u>	<u>Die Number</u>	<u>Form Description</u>	<u>Form</u>	<u>Die Number</u>	<u>Form Description</u>
	905-1	Middle Lead Offset with Lock-In Form		905-4A	Spread Form
	905-1A	Middle Lead Offset Form		905-4B	Reducing Form
	905-1CA	In-Line Lock-In Stand-Off Form		905-7	90° Angle Bend
	905-1H4 905-1H5 905-1L4	Middle Lead Offset with 3 Lead Lock-In Form		905-8A	Spread Form with Lock-In Stand-Off
	905-2	Stand-Off with Opposing Dimple Form		905-8B	Reducing Form with Lock-In Stand-Off
	905-2C	Lock-In Stand-Off with Opposing Dimple Form		905-10	Low Profile Stand-Off Lock-In Form
	905-3	Lock-In Stand-Off Form		905-11	Flush Mount Lock-In Form

This page left blank (almost).

Appendix C - CF-9 Accessories

The following optional accessories for GPD's CF-9 are specifically designed to help you increase production and profit.

Lead Forming Dies

The CF-9 operates on a system of dies and die blocks. Each combination is designed to form a specific lead configuration. Numerous standard and special CF-9 Lead Forming Die sets are available to provide a variety of component forms and lead configurations such as lock-ins, standoffs, standoff lock-ins, spreading, reducing, and ninety-degree bends. Many different die sets for various transistor hole patterns are also available. Dies are available to form two lead components with center-to-center dimensions up to .400" (10.16 mm) as well as 3-lead TO-92 transistors. All CF-9 dies will also work on the GPD CF-10 Loose/Bulk Component Lead Former.

Each die is clearly identified and color coded. This color coding, in combination with the roll pins, insures against installation mistakes. Changing dies is a matter of one screw. Remove the die you wish to change and replace it with a new die.

Standard dies are secured in place with 10-32x5/8" screws - these accompany the CF-9 machine. When a special die requires a longer screw, it is supplied with the die.

Most cutting and forming needs are covered with the standard dies we offer. However, if you have unusual requirements, GPD will be pleased to design custom dies for you. Your GPD representative will be happy to assist you with any custom die orders.

Component Detection System

The CF-9's Component Detection System option helps prevent die breakage by identifying bent components on tape and stopping CF-9 operations prior to a misaligned component entering the first die station.

Electronic Component Counter

The electronic counter is an automatic component counter that unerringly detects even the smallest component on the CF-9. Installation is simple and fast so that one counter can easily be moved from one CF-9 to another as counting requirements change.

The counter has two operation modes, pre-determining and totalizing. You can preset the total number of components you wish to run, and the counter's predetermining mode automatically shuts off the machine when the preset count is reached. The counter's totalizing mode gives you a cumulative count of all the components the machine has processed.

Counter Installation:

1. Remove cap screw (Figure 26, Item 2).
2. Slide counter bracket onto dowel pin (Item 1).
Replace and tighten cap screw to secure counter mounting.
3. Place counter on top of CF-9 cabinet.
4. Plug counter bracket wiring harness into counter's back panel.
5. Plug counter power cord with twist lock plug into accessory outlet on CF-9's control panel.
6. Plug counter's regular power cord into a power source per *Specifications*.

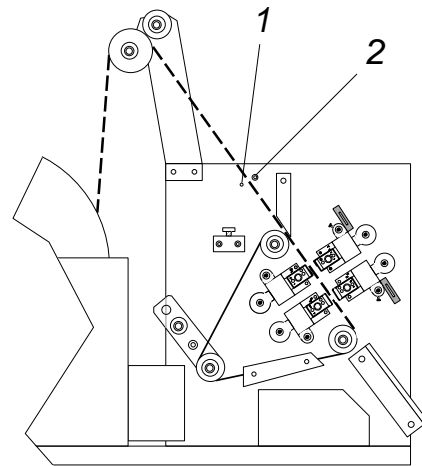

Figure 26 Electronic Component Counter Installation

Footswitch

The optional footswitch is a real operator convenience. After easily installing the footswitch, the operator need only position the CF-9 power switch to the AUX position and depress the footswitch to operate the machine.

Footswitch Installation:

1. Turn power switch to off.
2. Set speed control to zero (0).
3. Insert footswitch plug into accessory outlet on CF-9's control panel and turn clockwise to lock in place.
4. Set power switch to AUX position. The auxiliary mode indicator lights.
5. Set speed control to desired operating speed.

To remove footswitch, turn plug counterclockwise.

Lazy Susan (Rotating Machine Platform)

This rotating, circular platform allows the operator to easily rotate the entire machine to gain better access for setup, die changes, and normal maintenance. The Lazy Susan has been specifically constructed to operate smoothly under the CF-9's weight. Covered in ridged, anti-static material, this turntable holds the machine securely in any position with its unique graphite, anti-drift system.

Loose/Bulk Component Feeder

Process both taped and loose radial components on one machine by using the Loose/Bulk Component Feeder. This accessory provides the perfect solution when you need to form a relatively small number of components and they are not available or are too expensive on tape. Load up to ten (10) components in a magazine, place magazine in staging fixture, and then lightly press each component down to the top of staging fixture. Remove the magazine and your components are perfectly aligned, ready to feed directly into the CF-9 in exactly the same manner as you would feed a strip of taped components. There are four magazine sizes based on center-to-center requirements with a 1" (25.40 mm) minimum lead length requirement.

Taped Component Re-Reeler

Now you can form and re-reel radial components for automatic insertion in one operation. With this accessory, the CF-9 feeds taped components into the first die station, forms them, skips the normal trim operation and sends components straight to the Re-Reeler. Special flattening blocks can be inserted in the trimming station if additional dimple alignment is required. The re-reeler automatically reloads the taped components back on a reel after the forming process is complete.

The optional CF-9 Taped Component Re-Reeler has been specially modified with a slip clutch assembly on the drive motor shaft to allow the operator to adjust drive shaft tension. Increasing shaft tension causes taped components to wind tighter. Decreasing the tension results in more loosely wound components.

Work Station

The CF-9, dies, and various operational tools can all be mounted on this specially constructed work station which provides vibration free operations and optimum storage space. The CF-9 Work Station's heavy duty construction includes a 3/8" (9.53 mm) thick aluminum top, a 1" (25.40 mm) tubular steel frame, and inlaid steel panels.

This page left blank (almost).

Appendix D - Electrical Schematic & Assembly Drawing

<u><i>Drawing Title</i></u>	<u><i>Drawing Number</i></u>
CF-9 Electrical Schematic	0098001A
CF-9 Electrical Assembly Drawing	0098002A

This page left blank (almost).

Index

A

Accessories 18, 39
 Component Detection System 13, 39
 Electronic Component Counter 18, 39
 Footswitch 18, 40
 Lazy Susan 11, 40
 Lead Forming Dies 39
 Loose/Bulk Component Feeder 41
 Taped Component Re-Reeler 41
 Work Station 11, 41
Accessory
 Equipment 11
 Outlet 7, 40
Adjustment 8
 Component Alignment 17
 Component Body Height 15
 Component Body Thickness 15
 Hand Crank 6, 13, 14, 17, 18
 Slide Clearance 25
 Slide Travel 24
 Station 16
 Tape Hole to Lead 17
Ammo Pack 5, 19
AUX 18, 40

B

B1 9
B2 9
Belt Tension Release Bar 6

C

Capacities 29
 Micrometer 29
 Production Rate 29
Component
 3 Lead Radial 35, 37
 Alignment 17
 Ammo Pack 5, 19
 Bent 13
 Bin 5, 11
 Body Height 15
 Body Thickness 15
 Counter 39

Feeder 41
Leads 13
Load 18
Loose 41
Pathway 18
Pitch 13
Process 19
Re-Reeler 41
Reel 5, 19
Reel Tape 13
Tape Pressure Plate Lever 6
Taped 5
TO-92 Transistors 3
Transfer Belt 6
Component Detection System 13, 39
Control Panel 7
 Accessory Outlet 7
 Fuse 7
 Power Switch 7, 13, 18, 19
 Reset Button 7, 18, 19
 Speed Control 7, 11, 18, 19
Cover Plate 25
Crank
 Adjuster 24
 Pin 26
 Shaft 8
Cycles per hour 7

D

Die
 Breakage 13
 Custom 30
 Die Mounting Surface 14
 Functions 3
 Information 35
 Installation 9, 14
 Markings 9
 Number 35
 Sets 2
 Stations 1, 5, 8
Die Block 8
Die Block Assembly 5, 25
 Adjusting Bolt 8, 16, 25
 Cover Plate 8
 Crank Adjuster 8
 Crank Shaft 8

- Die Block 8
- Die Mounting Area 8
- Eccentric Crank 8
- Guide Shaft 8, 26
- Micrometer Scale Indicator 8, 16
- Slide 8, 14
- Wear Plate 8
- Die Markings
 - Forming Style Series 9, 35
 - Installation Color Dot 9
 - Installation Marking 9
- Dimensions 29
- Drive Pulley 6, 17

E

- E.I.A. Standards 30
- Eccentric
 - Crank 8, 25
 - Crank Shafts 26
- Ejector Brackets 15
- Electrical Schematic 43
- Electronic Component Counter 18, 39

F

- Flattening Blocks 5, 41
- Footswitch 18, 40
- Forming Style Series 9, 35
- Forms
 - Complicated Lead 15
 - Lead 3, 37
- Function
 - CF-9 3
 - Dies 3
 - Station 1 5
 - Station 2 4, 5
- Fuse 7

G

- Gauge Block 24
- Guide Shaft 8

H

- Hand Crank 6, 13, 14, 17, 18, 23

I

- Indexing System 1
- Installation 11
 - Color Dot 9
 - Die 14
 - Die Markings 9
 - Die Position 9
 - Ejector Brackets 15
 - Electronic Component Counter 40
 - Footswitch 40
 - Marking 9

K

- Knives 9

L

- Lazy Susan 11, 40
- Lead 13, 17
 - 3 Lead Radial 35, 37
 - Center-to-Center Dimensions 3
 - Complicated Lead 15
 - Cut Length 8, 16
 - Diameters 3
 - Forming Dies 39
 - Forms 3, 37
 - Point of Attachment 16
- Load Components 18, 19
- Loose/Bulk Component Feeder 41

M

- Machine Upright Plate 16, 25
- Maintenance 21
- Micrometer Scale 1, 8, 16, 25, 29

O

- Operating
 - Clearance 30
 - Instructions 13

P

Part Identification 5

Power

Off 19

On 18

Requirements 29

Power Switch 7, 13, 18, 19

AUX 18, 40

Pressure Plate Lever 6, 18

Preventive Maintenance 21

Process Components 19

Production Rate 29

Hole-to-Hole Spacings 3

Operating Clearance 30

Pressure Plate Lever 6

Roller Guide 1, 5

Taped Component Re-Reeler 41

Taped Components 5

Custom 30

Taping Specifications 30

Tension Release Bar 6

Theory of Operation 4

Transfer Belt 6, 18

Troubleshooting 23

Guide 23

Hand Crank 23

R

Reel Holder 5, 11, 19

Reset Button 7, 18, 19

S

Safety

Shield 6, 11, 18, 19

Shield Lock 6, 18

Screw Sizes 11, 14, 39

Serial Number 11

Setup 13

Slide Clearance 25

Slide Travel 24

Gauge Block 24

Spare Parts 31

Specifications 29

Taping 30

Speed Control 7, 11, 18, 19

Station

Action 16

Adjustment 16

Guide Shaft 8

Position 16

Station 1 5, 14

Station 2 4, 5, 14, 15

Work 41

T

T1 9, 25

T2 9, 25

Tape 13

Exit Chute 1, 5

Guide Arm 5, 11

Hole to Lead Distance 17

W

Wear Plate 25

Weight 29

Work Station 11, 41

Z

Zero (0) Reference Point 16

